

Data Sheet



Article number: 2314451516

Description: E+G Aluminiums wheel 451516
RE.F5-150-RSL loose

Measures

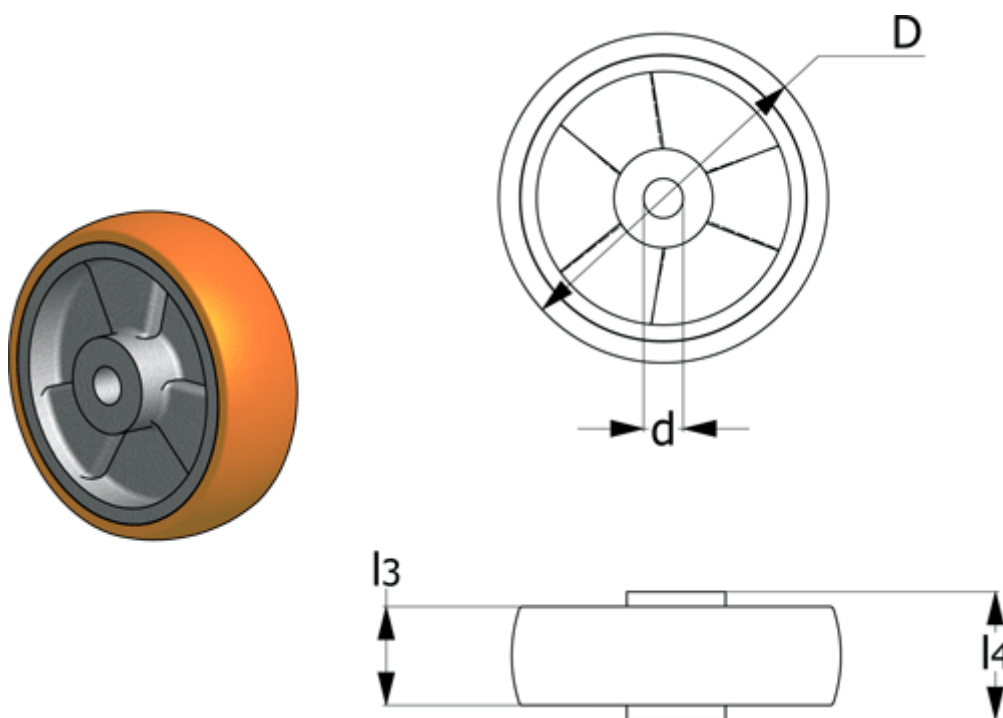

Code	= 451516
d	= 20
D	= 150
Dynamic load (N)	= 6000
l3	= 40
l4	= 50
Max static load (N)	= 8500
Rolling resistance (N)	= 3300

Type	= RE.F5-150-RSL
Weight (g)	= 910